

CMAF01

FLASHER

Features

- Special integrate circuit,stable reliable performance
- Use of special high performance contacts, ultra-long electrical endurance
- Surface mounting technology,advanced technology
- Solid base design,stable structure
- Protection IP50
- Steering light of the automobile control, Hazard warning flash lamp control

Flasher Picture

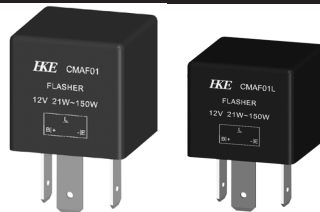

ORDERING INFORMATION

CMAF01 **L** - **DC12V** - **A** - **Z** - **P**

Model	Cover height	Coil Voltage	Contact Form	Mounting	Polarity source
	Blank - High cover L - Low cover	DC12V DC24V	A - NO	Blank - With bracket Z - Without of bracket	Blank - Positive polarity P - Reverse polarity

Remark: CMAF01L is not applicable for 24V

SPECIFICATION

Type	CMAF01		CMAF01L	
Output Mode	Single output		Single output	
Norminal Voltage	12VDC/24VDC		12VDC	
Operating Voltage	12V System	9VDC~16VDC	9VDC~16VDC	
	24V System	18VDC~32VDC	-	
Norminal Load	Turning Mode	2×21W+5W	2×21W+5W	
	Hazard warning mode	2×(2×21W+5W)	2×(2×21W+5W)	
	Failure mode	21W+5W	21W+5W	
Flash Frequency	(60~110)ops/min		(60~110)ops/min	
Lamp Failure Flash Frequency	(140~230)ops/min		(140~230)ops/min	
Electrical Endurance	12V	1000h(Turning15s on / 15s off)	1000h(Turning15s on / 15s off)	
		360h(hazard warning continuously)	360h(hazard warning continuously)	
	24V	400h(Turning15s on / 15s off)	-	
		200h(hazard warning continuously)	-	
Duty cycle	30%~70%		30%~70%	
Ambient temperature	-40℃~85℃		-40℃~85℃	
Vibration resistance	10Hz~200Hz,49m/s ²		10Hz~200Hz,49m/s ²	
Shock resistance	196m/s ²		196m/s ²	
Mechanical	Cover retention	≥160N	≥160N	
	Terminal retention	≥100N	≥100N	
Weight	Approximately 40g		Approximately 30g	

CMAF01

FLASHER

OUTLINE, WIRING DIAGRAM, MOUNTING HOLE LAYOUT (UNIT: mm)

CMAF01

With bracket

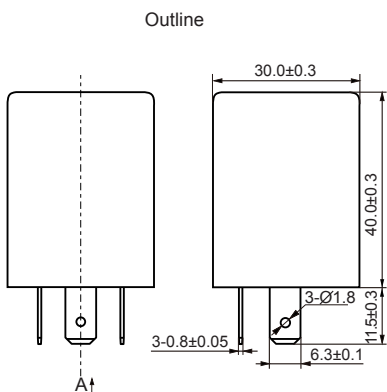

Mounting Hole Layout
(Bottom View)

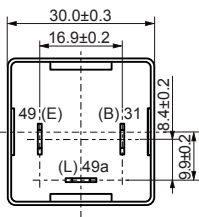

Wiring Diagram
(Bottom View)

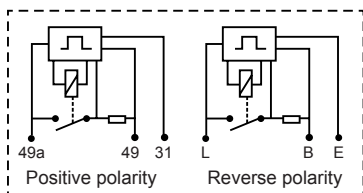

Without of bracke Outline

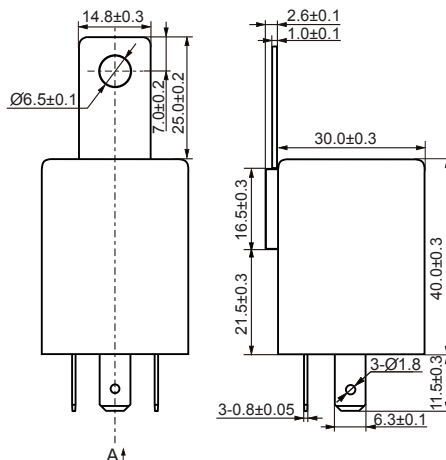

Mounting Hole Layout
(Bottom View)

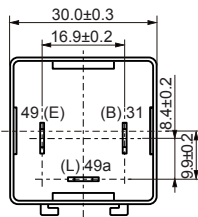

As shown in wiring diagram (refer to bottom view), terminal of 49(B) is connected with positive polarity of 12V or 24V power supply, terminal of 31(E) is connected with reserve polarity of power supply, terminal of 49a(L) is connected with lamp load. The flasher will operate by the frequency of (6~110) ops/min when the lamp load is 2×21W+ 5W or 4×21W+ 2×5W; The flasher will operate by the frequency of (140~230) ops/min when the lamp load is 1×21W+ 5W(one of 21W lamp is failure).

OUTLINE, WIRING DIAGRAM, MOUNTING HOLE LAYOUT (UNIT: mm)

CMAF01L

With bracket

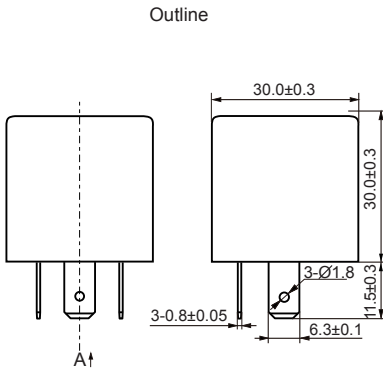

Mounting Hole Layout
(Bottom View)

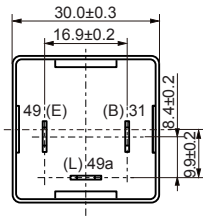

Wiring Diagram
(Bottom View)

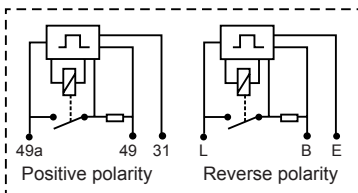

Without of bracke

Outline

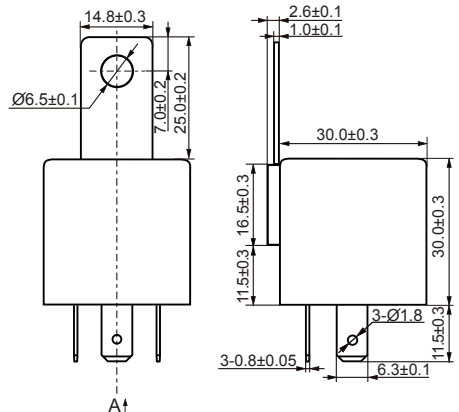

Mounting Hole Layout
(Bottom View)

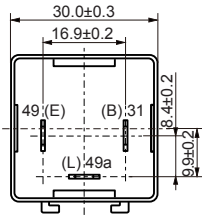

As shown in wiring diagram (refer to bottom view), terminal of 49(B) is connected with positive polarity of 12V or 24V power supply, terminal of 31 (E) is connected with reserve polarity of power supply, terminal of 49a (L) is connected with lamp load. The flasher will operate by the frequency of (6~110) ops/min when the lamp load is 2×21W+ 5W or 4×21W+ 2×5W; The flasher will operate by the frequency of (140~230) ops/min when the lamp load is 1×21W+ 5W(one of 21W lamp is failure).